

Process Controller _____

PX series

INSTRUCTION MANUAL

Thank you for the purchase of **HANYOUNG** product.
Please read this manual carefully.



Contents

1. SAFETY INFORMATION	P. 3
2. INSTRUCTION	P. 5
3. ORDERING INFORMATION	P. 5
4. SPECIFICATION	P. 6
5. DIMENSIONS & PANEL CUTOUT	P. 10
6. TERMINAL ARRANGEMENT	P. 11
7. NAME & FUNCTION	P. 12
8. TABEL OF SETTING ITEMS	P. 13
9. SETTING METHOD	P. 15
10. CONTROL GROUP	P. 16
11. INPUT GROUP SETTING	P. 17
12. INPUT SIGNAL AND MEASUREMENT RANGE	P. 18
13. OUTPUT GROUP SETTING	P. 19
14. SET VALUE GROUP SETTING	P. 20
15. PROGRAM GROUP SETTING	P. 21
16. AUTO TUNING	P. 22
17. P.I.D GROUP	P. 23
18. ALARM GROUP SETTING	P. 24
19. ALARM TYPE AND CODE	P. 25
20. RETRANSMISSION GROUP	P. 26
21. COMMUNICATION	P. 26
22. HEATER BREAK ALARM GROUP	P. 27
23. REMOTE INPUT GROUP	P. 27

PX Series

High Accuracy 0.1 class 250 ms





Features

- Fuzzy
- Auto Tuning
- Alarm Output
- Retransmission Output
- Multi Input • Output
- External Contact Input
- Ramp soak function
- Heating / Cooling
- Zone PID
- Group PID
- Power supply for sensor
- Output Limits
- Interface (RS485 / 422)
- 3 Set points
- Heater break alarms (HBA1, HBA2)
- IP65 Front facia

1 SAFETY INFORMATION

Before using, please read this (SAFETY INFORMATION) and then use this controller.
It is important that the instructions in this manual are followed when using this instrument.
Please keep this manual for future reference.
Precautions are classified in **WARNING** and **CAUTION**.

 WARNING	There is a possibility of death or heavy injury when handling in wrong way.
 CAUTION	There is a possibility of injury or physical damage when handling in wrong way.

WARNING

1. Caution on wiring

- Use an external protection circuit if a fault in the control loop could possibly lead to a serious problem.
- This instrument do not have a switch for power and a fuse, so please set them if it is needed.
(Fuse rating 250 V, 0.5 A)

2. Power supply

- Use a rated voltage to prevent damage or trouble.
- To avoid electrical shock or damage, do not turn ON the power until the wiring is completed.

3. Prohibit use in gas atmosphere

- Do not use it at a place exposed to combustible or explosive gas.

4. Handling of unit

- To avoid malfunction, electrical shock or fire, this unit must not be disassembled or repaired.
- Do not touch the terminals to avoid electrical shock or malfunction.

5. Caution on maintenance

- Turn OFF the power before mounting or removing the instrument.
- To ensure continuous and safe operation of the instrument, periodical maintenance is recommended. Some parts are limited in life.
- The warranty period is 1 year only if using in the correct way.

CAUTION

1. Caution on handling

Do not install the instrument under any of the following conditions.

- The ambient temperature exceeds 0 ~ 50 °C
- The ambient humidity exceeds 45 ~ 85 % RH.
- A place where temperature changes suddenly or icing occurs.
- A place exposed to corrosive gas or combustible gas.
- Vibration or shock is likely to be transmitted to the instrument.
- A place exposed to water, oil, chemicals, steam, sunlight.
- A place exposed to much dust, salt or iron.
- A place with much inductive disturbance, static electricity, magnetism noise.
- A place where heat such as radiant heat stays.

2. Installation

- Attach the brackets (2 units) on the fixed halls and tighten with a screwdriver.
Fixing torque is about 147 N. cm (1.5 kg.cm)
(Care should be taken not to tighten forcedly)

3. Caution on terminal connections

- To avoid induction noise to input wires separate from the power and output wires.
- Keep input wires away from output wires and use shielded wires to earth.
- Use a compensating cable with thermocouple.
- For R.T.D input use a cable which is a small lead wire resistance and without resistance difference to 3 wires.
- If the wiring has noise, use the following step: connect a surge absorber to the conductor coil side if the conductors are connected to the load output, such as the relay contact output.
(EX. For 220 V AC ENC 471D-05A)
- Use an insulating transformer with a noise filter when the power supply has much noise.
(EX. TDK brand ZMB 22R5-11 noise filter)
- Noise filter should be mounted on a panel which has been earthed and the wiring between the noise filter output and the instrument power terminals should be shorten.
- It is effective to use a twisted cable for power supply against noise.
- The heater power supply and the instrument power supply should be connected using the same power supply when a heater break alarm.
- Time for preparation of contact output is required at power ON. When the output signal is used for an external interlock circuit, connect a delay relay.

4. For load circuit connection

- Use an extra relay when the frequency of operation is rather high. SSR output type is recommended.
 - Electromagnetic switch : Proportional cycle time is Min. 30 sec
 - SSR : Proportional cycle time is Min. 1 sec
 - Contact output life : Mechanical : 10 million times (no load)
Electrical : 100 thousand times (rated load)
 - SSR drive pulse voltage, 4 ~ 20 mA DC are not insulated with internal circuit.
Use non-grounded sensor to R.T.D and thermocouple.

5. For waterproof (Waterproof type)

The instrument has IP65. Use rubber packing when installing the instrument to panel.
Please attach the rubber in correct way.

6. Caution on key operation / trouble

- If alarm function is not set correctly, alarm output can not be operated at a trouble point.
Be sure to check the alarm operation.
- If the input cable is disconnected, the display shows " *bOUT* ".
When replacing the sensor, please turn OFF the power supply.

7. Other

Do not use organic solvents such as alcohol, benzene when cleaning. (Use neutral detergent)

2

INSTRUCTION

This instrument has process-value (PV) and set-value (SV) each 4 digits with 7 segment FND. This instrument is available in 2 versions: Universal Type and Heating / Cooling Type. Each has 12 Setting groups (refer pages 9 & 10)

Function and feature : Group P.I.D, Multi-input (19 types), Multi-output (Relay, SSR, Current), Local input, Remote input, External contact input, Program Control (Ramp / Soak) with 10 steps, Auto-tuning 2 types (standard type, low PV type), Manual output, Retransmission, Communication (RS485 /422), Power supply for sensor, 22 types of alarm, Sampling cycle 250 ms, 0.1 % FS high accuracy.

3

ORDERING INFORMATION

Model	Suffix code	Description
PX2 -	<input type="checkbox"/>	Process Controller (48 × 96 mm)
	0	Universal
	1	Heating / Cooling

Model	Suffix code	Description
PX3 -	<input type="checkbox"/>	Process Controller (96 × 48 mm)
	0	Universal
	1	Heating / Cooling

Model	Suffix code	Description
PX7 -	<input type="checkbox"/> <input type="checkbox"/>	Process Controller (72 × 72 mm)
	0	Universal
	1	Heating / Cooling
	0	None
	1	RS485, OUT2 (SSR/SCR/RET), REM
	2	RS485, OUT2 (SSR/SCR/RET), HBA 1 contact
	3	DI-1, DI-2, OUT2 (SSR/SCR/RET), HBA 1 contact

Model	Suffix code	Description
PX9 -	<input type="checkbox"/> <input type="checkbox"/>	Process Controller (96 × 96 mm)
	0	Universal
	1	Heating / Cooling
	0	None
	1	RS422 / 485, HBA 2 contacts, REM

4

SPECIFICATION

■ INPUT

Input	Thermocouple, R.T.D, Direct voltage (refer to the input signal and measurement range on page 18)
Sampling cycle time	250 mS
Input resolution	Below decimal point of range
Input impedance	Thermocouple / Voltage (mV) input : 1 M Ω or above Voltage input (V) : Approx. 1 M Ω
Allowable signal source resistance	Thermocouple : 250 Ω or below Voltage input : 2 k Ω or below
Allowable wiring resistance	R.T.D : 150 Ω or below / 1 wire
Allowable input voltage	Thermocouple, R.T.D, Direct voltage (mV) : ± 10 V Direct voltage (V) : ± 20 V
Noise ratio	NMRR :40 dB or above CMRR :120 dB or above (50/60 Hz ± 1 %)
Standard	Thermocouple / R.T.D (KS / IEC / DIN)
Standard junction temperature compensation tolerance	± 1.5 $^{\circ}\text{C}$ (15 ~ 35 $^{\circ}\text{C}$), ± 2.0 $^{\circ}\text{C}$ (15 ~ 50 $^{\circ}\text{C}$)
Burn-out detection	OFF, Up / Down scale selectable Thermocouple burn-out : Up / Down scale R.T.D burn-out : Up scale (TC / R.T.D burn-out detection current : Approx. 50 nA)
Accuracy	0.1 % of F.S

■ POWER SUPPLY

Power supply voltage	100 - 240 V \sim , 24 V \approx
Frequency	50/60 Hz
Voltage variation	-10 % +10 %
Power consumption	Max. 6.0 W, 10 VA or below
Power supply for sensor	27 V - 20 mA (but, it is not available when using retransmission output)
Insulation resistance	20 M Ω min. (at 500 V DC) Between primary terminal and secondary terminal Between primary terminal and ground Between ground and secondary terminal
Dielectric strength	2300 V AC 50/60 Hz for 1 minute Between primary terminal and secondary terminal Between primary terminal and ground Between F.G and secondary terminal : 1500 V AC 50/60 Hz for 1 minute

■ Division of insulation

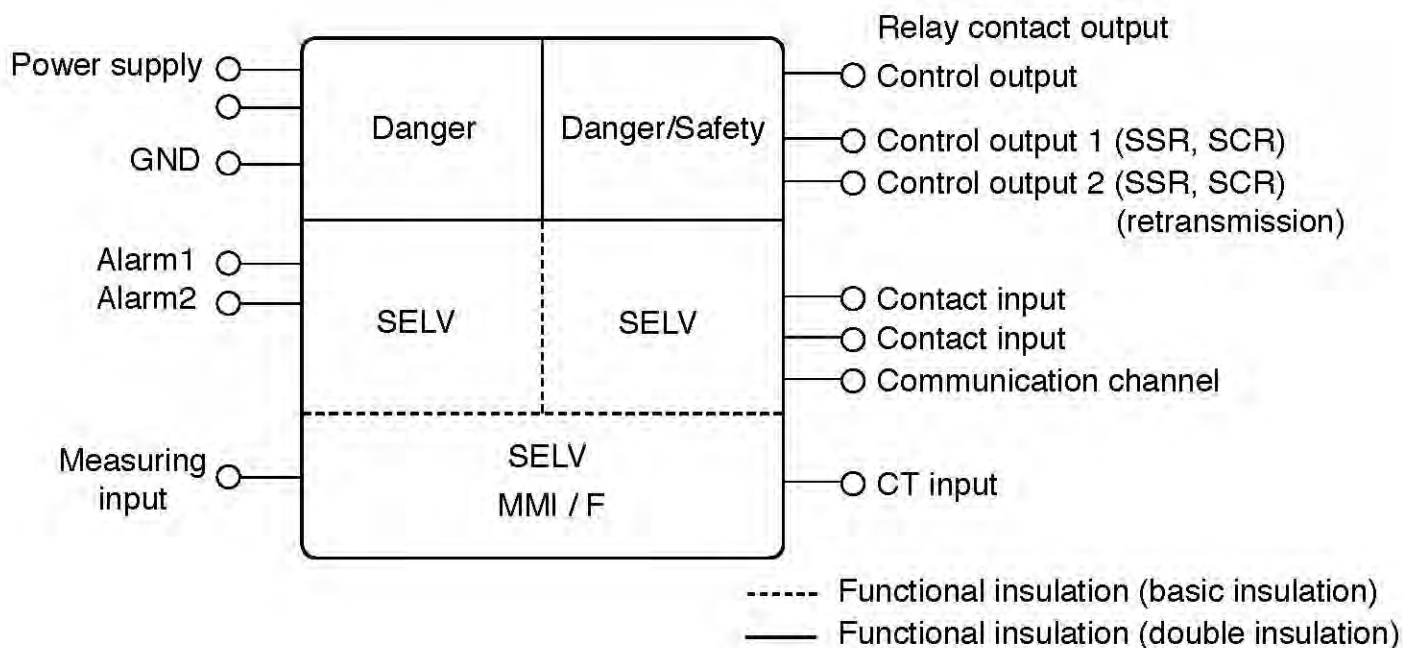

■ OUTPUT

● CONTROL OUTPUT

Relay contact output	Contact capacity : 240 V AC 3 A, 30 V DC 3 A (Resistance load) Contact structure : 1 c Output action : Propotional or ON / OFF action Proportion cycle time : 1 ~ 1000 sec. Output limit : Higher (OH) or lower limit (OL) selectable within 0.0 ~ 100.0 % range. It is also available in Auto tuning ON / OFF hysteresis : 0 ~ 100 % Time resolution : 0.1 % or 10 ms
SSR output	ON voltage : 12 V DC min.(Resistance load: 600 Ω min, 30 mA limit when short) OFF voltage : 0.1 V DC max. Output action : Proportional action Proportion cycle time : 1 ~ 1000 sec. Output limit : Higher (OH) or lower limit (OL) selectable within 0.0 ~ 100.0 % range. It is also available in AT and MAN. Time resolution : 0.1 % or 10ms (whichever is larger)
Current output	Output current range : 4 ~ 20 mA DC Resistance load : 600 Ω max. Accuracy : ± 0.3 % of F. S (4 ~ 20 mA) Resolution : Approx. 3000 Output ripple : 0.1 % of F. S (p-p) 150 Hz Output update cycle time : 250 m sec. Output action : P.I.D control Output limit : Higher (OH) or lower limit (OL) selectable within -0.5 ~ 105.0 % range. It is also available in AT and MAN.
Manual operation	It is changeable by A/M key, external contact and communication. AT \rightarrow MAN : TRACKING MAN \rightarrow AT : BUMPLESS CONVERSION

●RETRANSMISSION OUTPUT

Current output	Output current range : 4 ~ 20 mA DC, Resistance load : 600 Ω max. Accuracy : +0.3 % of F. S (4 ~ 20 mA), Resolution : Approx. 3000 Output ripple : 0.1 % of F. S (p-p), 150 Hz Output update cycle time : 500 msec (When remote option)
----------------	--

●ALARM OUTPUT (HBA COMMON)

Alarm output	Output : Relay contact, Output contact : 3 points Contact capacity : 240 V AC 1 A , 30 V DC 1 A (Resistance load) Contact structure : 1 a
--------------	---

●COMMUNICATION INTERFACE

Communication Interface	Standard : EIA RS485 Number of devices (Max.) : 31, Address setting : 1~99 range Communication type : 2-wire or 4-wire half-duplex Synchronization : Asynchronous Communication order : None Communication distance : Max. 1200 m Communication rate : 600, 1200, 2400, 4800, 9600 Start Bit : 1Bit, Data length : 7 or 8 Bit, Parity : None, Even, Odd Stop Bit : 1 or 2 Bit, Protocol : PC LINK Response time : Handling time + (RP.T × 10 ms)
-------------------------	---

●HEATER BREAK ALARM

Heater break alarm	Output contact : 2 points Current measurement range : 1 ~ 50 A AC (Resolution 0.5 A, =5 % of F.S ± 1 Digit) Alarm output : AL1, 2 output It is available to use in ON / OFF or proportional action. (not available in current or cooling output) Minimum detection time : 0.2 sec, Dead Band : 0 ~ 100 %
--------------------	--

●SAFETY AND EMC STANDARDS

Safety and EMC Standards	Safety standards: IEC1010-1-1990 and EN61010-1-1992; CSA1010 CAT II (IEC1010-1); and UL508. EMC Standards: EN55011 Class A, Group 1, for emission (EMS); and EN50082-2-1995 for immunity(EMI). The indicator continuously operates within a measuring accuracy of ±20 % of the range. EN61000-3-2, EN61000-3-3
--------------------------	---

●Ambience

Installation Conditions (for normal operation)	Ambient temperature : 0 ~ 50 °C Ambient humidity : 20 ~ 90 % RH (No condensation) Installation place : Indoors, Magnetic effect : 400 AT/m max. Vibration : 5 ~ 14 Hz, forth width 1.2 mm max. 4 ~ 150 Hz, 4.9 m/s ² (0.5 G) max. Shock : 147 m/s ² (15 G), 11 msec max., Height : 2000 m max. Installation category : II (EN61010-1), Pollution degree : II (EN61010-1) Storage temperature : -25 °C ~ 70 °C, Storage humidity : 5 ~ 95 % RH Case : Plastic Weight : PX2 (342 g), PX3 (340 g), PX7 (344 g), PX9 (472 g) ※ Including brackets (Brackets 40 g)
--	---

5

DIMENSIONS & PANEL CUTOUT

(Unit : mm)

■ PX2 (48 × 96 mm)

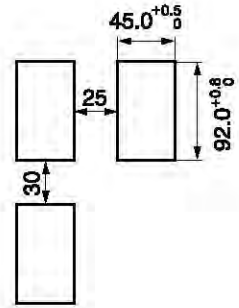
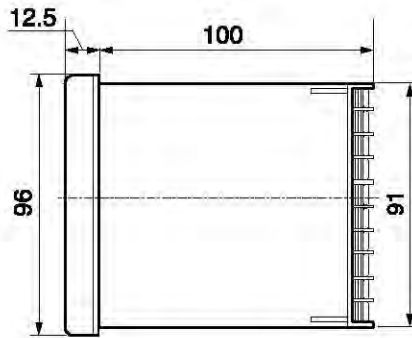

■ PX7 (72 × 72 mm)

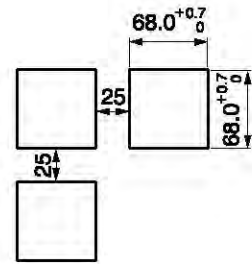
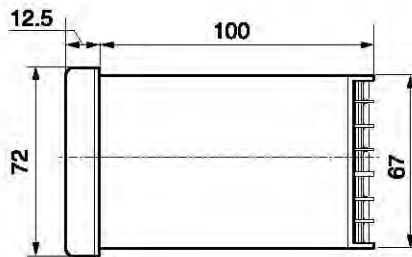
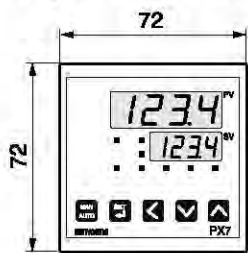

■ PX3 (96 × 48 mm)

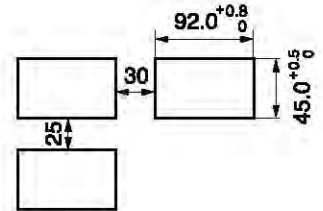
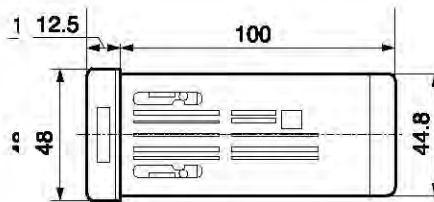
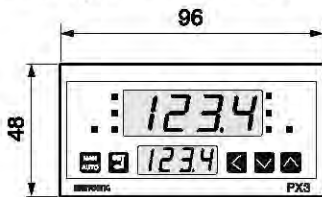

■ PX9 (96 × 96 mm)

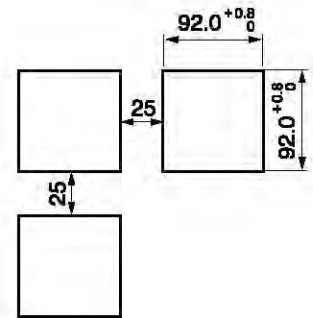
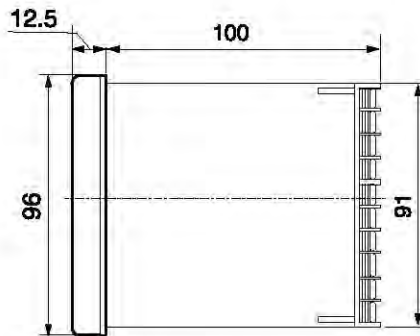

■ CURRENT TRANSFORMER (Model: CTL-6-S)

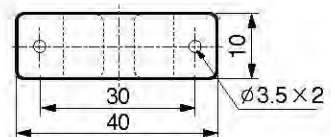
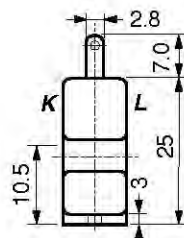
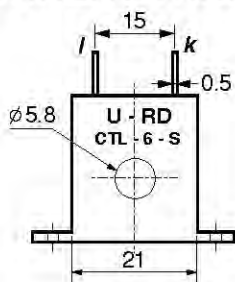

6

TERMINAL ARRANGEMENT

■ PX2 (48 × 96 mm)

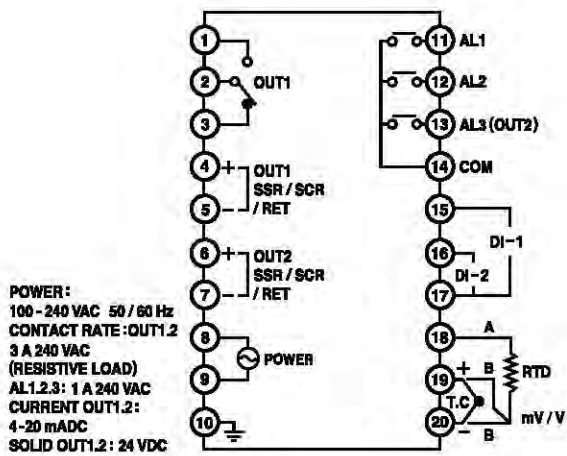

■ PX3 (96 × 48 mm)

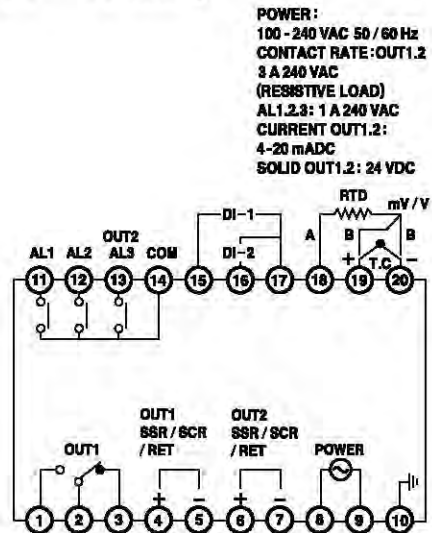

■ PX7 (72 × 72 mm)

Optional

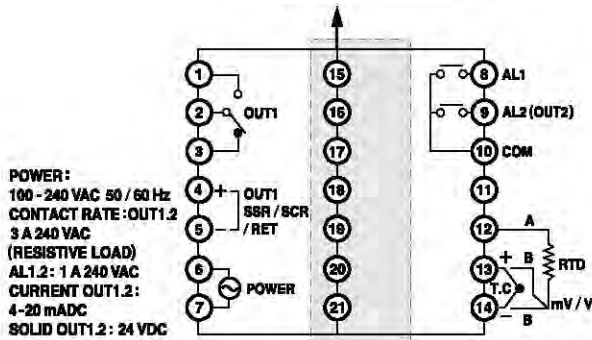

Optional 1

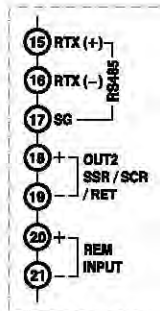

Optional 2

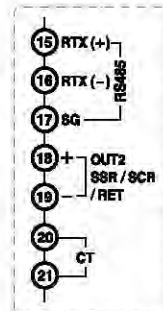

Optional 3

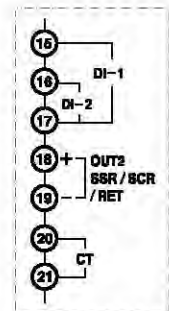

[Note] Heater break alarm is used in option 2,3 by setting alarm outputs (AL1,AL2)

■ PX9 (96 × 96 mm)

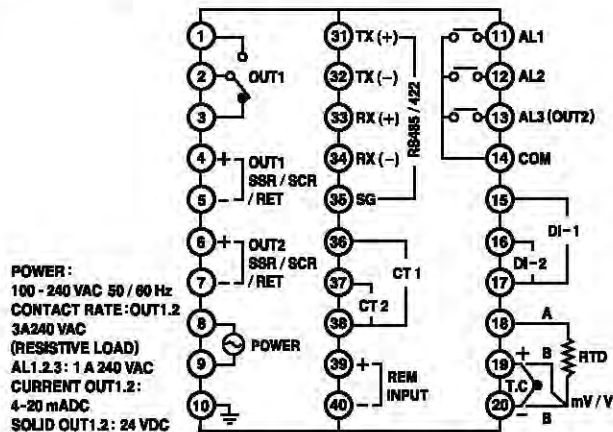

[Note] Heater break alarm is used by setting alarm outputs (AL1,AL2,AL3)

7 NAME & FUNCTION

■ Front

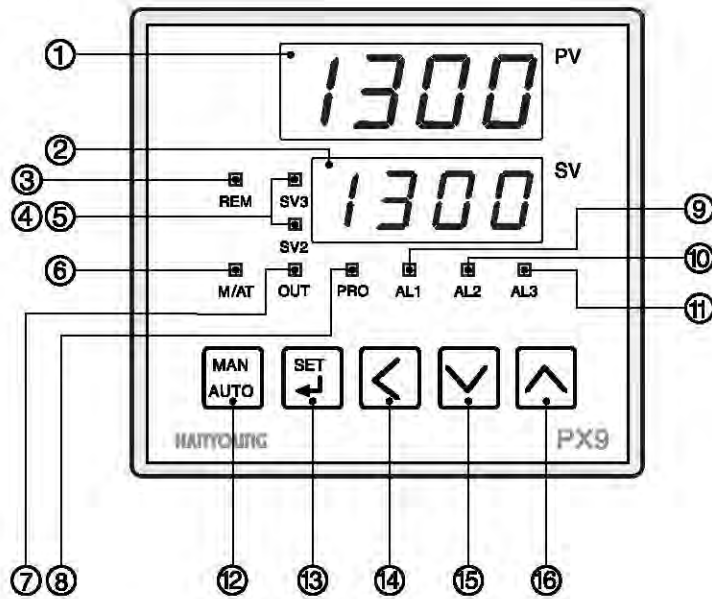

■ Displays

Name of respective parts	Functions
① Process-value (PV)	Displays the process temperature value.
② Set-value (SV)	Displays various set - value, message, and parameter.
③ Remote indicator	Lights when the remote operation.
④ ⑤ Set-value display indicator	Lights when the SV2 or SV3 is displayed.
⑥ Manual /Auto tuning indicator	This lamp lights when Manual control.(It does not light for AT)
⑦ Output indicator	Lights when the control output is ON.
⑧ Program display indicator	Lights during program operation.
⑨ Alarm 1 indicator	Lights when the alarm 1 operates.
⑩ Alarm 2 indicator	Lights when the alarm 2 operates.
⑪ Alarm 3 indicator	Lights when the alarm 3 operates.

■ Control keys

Key	Functions
⑫	Used to select Auto or Manual control.
⑬	Used to change from the operation mode to the setting mode, to select parameters, and to register set-value. Press this key for 3 sec to display setting mode, set-value, and process value.
⑭	Used to select digit for changing.
⑮	Used to decrease set-values and to select setting mode.
⑯	Used to increase set-values and to select setting mode.

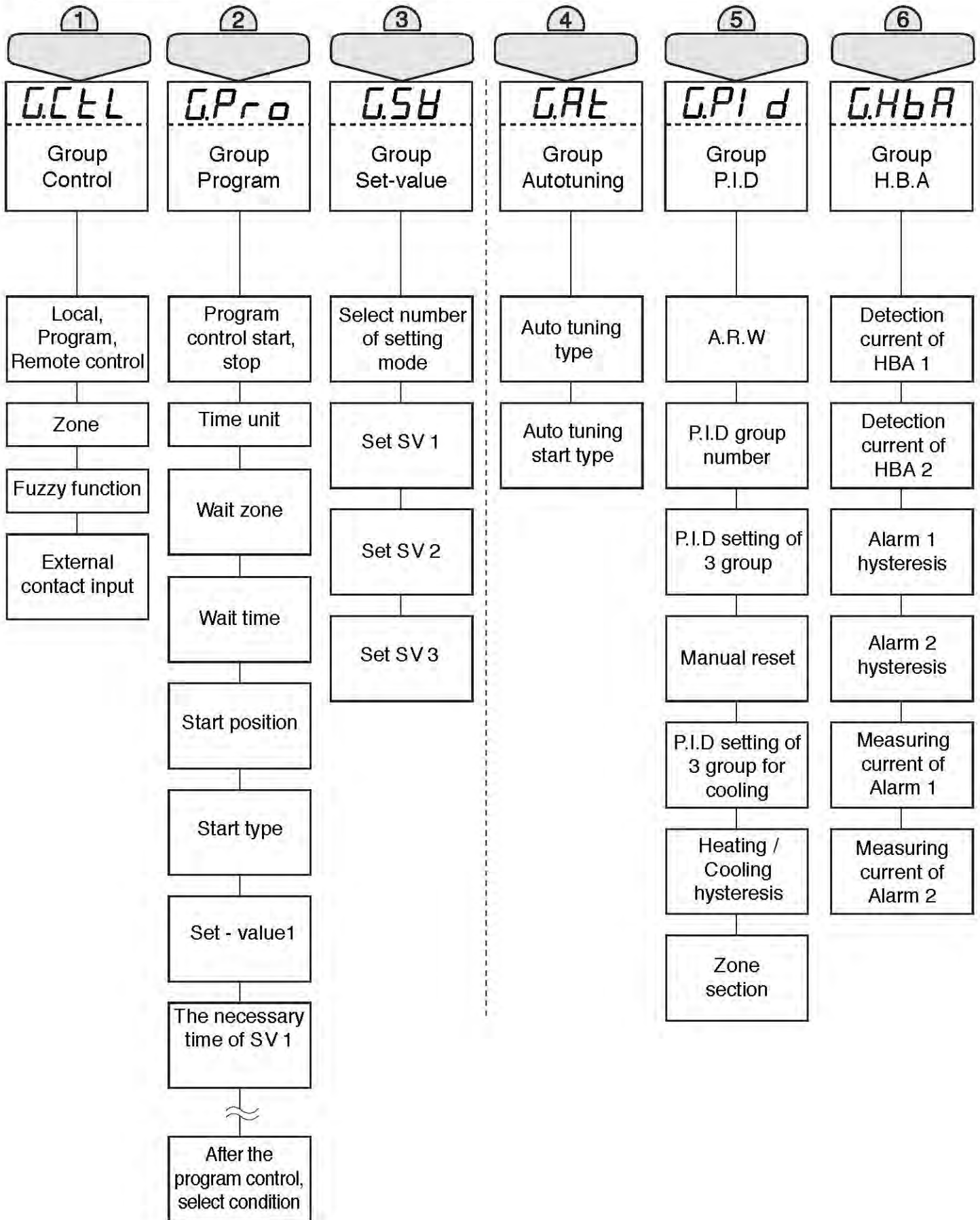

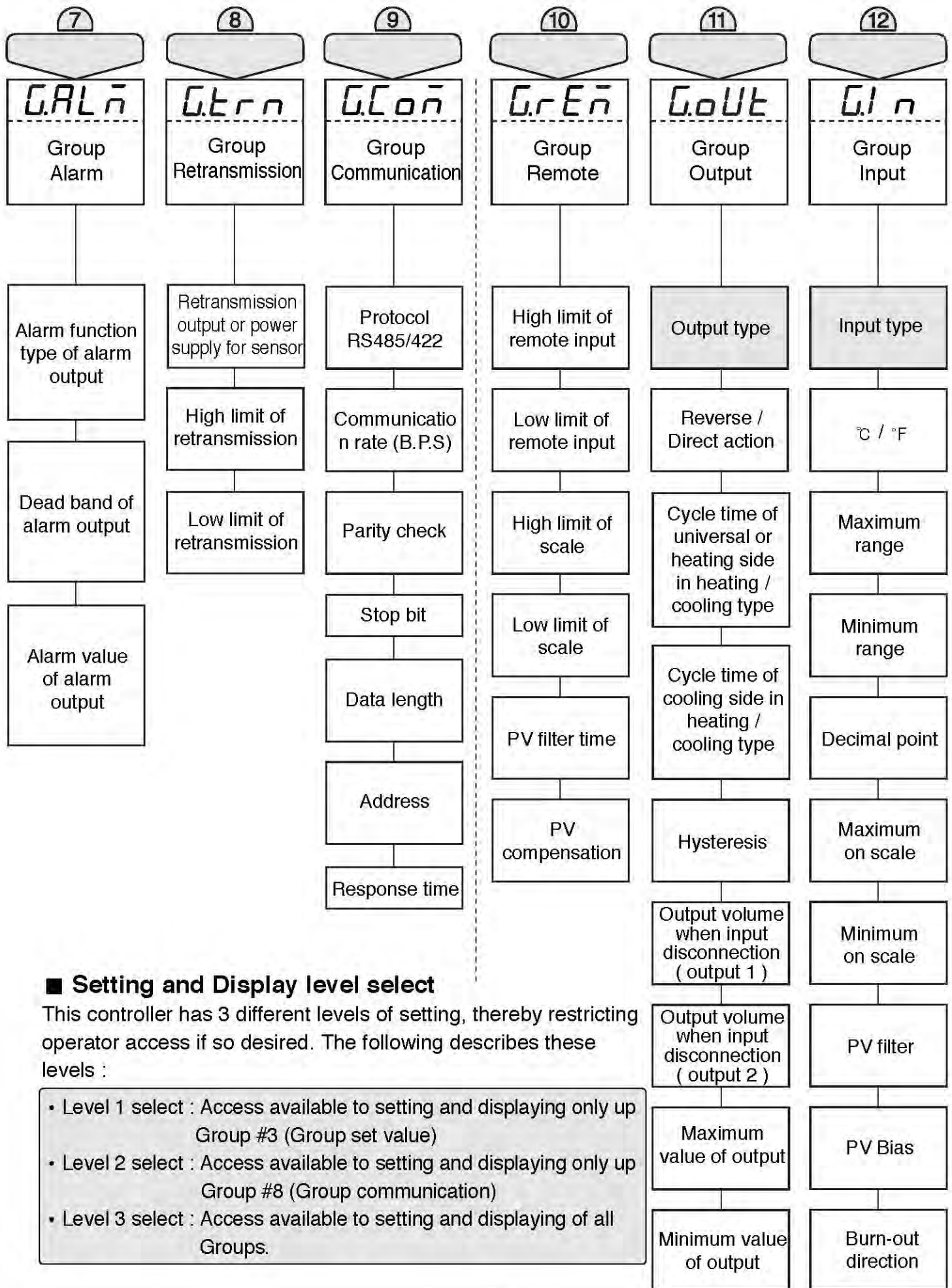

■ Setting and Display level select

This controller has 3 different levels of setting, thereby restricting operator access if so desired. The following describes these levels :

- Level 1 select : Access available to setting and displaying only up Group #3 (Group set value)
- Level 2 select : Access available to setting and displaying only up Group #8 (Group communication)
- Level 3 select : Access available to setting and displaying of all Groups.

10 GROUP SETTING

- Local, Program or Remote is selected in the control group mode using or key.
- When selecting LOCAL mode, control zone selection and fuzzy function selection are available.
- Control zone selection is not available when selecting program mode or remote mode.
- Fuzzy function is operating in the P.I.D control. (not operating in the ON/OFF control)
- Using two external contact input (DI) as ON/OFF, it is possible to control 3 kinds setting values and Auto operation or Manual operation is selectable in the start, reset, local mode.

DIS selection	External input signal		Functions
OFF	Initial value is OFF (None)		
1	DI-1	OFF	SV 1 display and selection
		ON	SV 2 display and selection
	DI-2	OFF	Auto control
		ON	Manual control
2	DI-1	ON	Start (Program control)
		OFF	Reset (Program control)
3	DI-1	OFF	SV 1 display and selection
	DI-2	OFF	
	DI-1	OFF	SV 2 display and selection
	DI-2	ON	
	DI-1	ON	SV 3 display and selection (When DI-1 and , DI-2 are ON, it is same)
	DI-2	OFF	



(Chart1)





Signal	Name	Operation	Display condition	Initial Value
	Control group display	Set a control mode	—	—
	control mode selection	LOCA / PROG / REM	Always display	LOCA
	Zone selection *1	OFF / ON	When local mode selection	OFF
	Fuzzy function selection	OFF / ON	When P.I.D control	OFF
	External contact input selection	(Refer to chart 1) OFF / 1 / 2 / 3	Always display	OFF

* 1 : This signal is not indicated in Program or Remote operation.
Zone P.I.D will be operated.

11 INPUT GROUP SETTING

● Input type selection

After power ON and when PV is indicating, press  key for 3 sec to be displayed  at PV and 3 at SV. (If it is not indicated 3, set again in the level setting mode)



① Control group is indicated when press  key once more. At the time, ⑫ input group is indicated when press  key and then "Input type and range selection" is shown at SV when press . At this time the input and range is selected by  or  key.

CAUTION





When setting, "Input type selection number" must be selected in the input type selection mode and also "Output type selection number" must be selected in the output type selection mode before moving to other mode.

If not, data of other group will be changed to prior value.

● Display unit (°C/°F)

After selecting input type and range, press  key to select display unit. Press  key to choose °C or °F and press  key when finishing selection.

● Maximum and Minimum range

After selecting display unit, press  key to set Maximum and Minimum range using  or  key. Press  key once more to finish.

● Decimal point

Parameter is not indicated in T.C and R.T.D input, but when selecting voltage input (code 30,32,33), "Decimal point" mode is indicated. (set 1 : 0.0, set 2 : 0.00, set 3 : 0.000)

● Maximum and Minimum on scale

It is the same function as Maximum and Minimum range setting when R.T.D or thermocouple input. This mode is indicated when voltage input (30, 32, 33)



● PV filter

When PV value becomes unstable due to effects of noise, the filter helps suppress the unstable status. (Range: OFF or 1 ~ 120 sec. Initial value: OFF)

● PV bias

Use this function to adjust PV value in cases where it is necessary for PV value to agree with another recorder or indicator, or when the sensor cannot be mounted in correct location.

(Range : -100.0 ~ 100.0 % of SPAN, Initial value : 0.0 %)

Setting a value using  or  key and press  key to finish.

Signal	Name	Description	Condition	Initial value
	Input group	Input type and mode selection	—	—
	Input signal selection	Refer to input signal and range	Always	Selection NO.1
	Measurement range unit	°C/°F	Thermocouple or R.T.D	°C
	High limit	Refer to input signal and range (Notice : FR-H > FR-L)	Always	1370
	Low limit			-200
	Decimal point	Thermocouple or R.T.D : decimal point of instrument / DC Voltage : 0~3	On voltage input (mV,V)	1
	Maximum on scale (on voltage input)	-1999 ~ 9999 Notice : SL-H > SL-L Deimal point : according to DP-P	On voltage input (mV,V)	100.0
	Minimum on scale (on voltage input)			0.0
	PV filter	OFF / 1 ~ 120 sec	Always	OFF
	PV bias	EUS (-100.0 ~ 100.0 %)	Always	EUS(0.0 %)
	Burn-out	OFF / UP / DOWN	Always	UP

12 INPUT SIGNAL AND MEASUREMENT RANGE

Input code	Input signal	Range (°C)	Range (°F)	Accuracy	Remarks
1	K * 2	-200~1370	-300~2500	- 0.10% of F.S - 1digit	F.S is maximum value of each RANGE
2	K * 2	-199.9~999.9	0~2300		
3	J * 2	-199.9~999.9	-300~2300		
4	E * 2	-199.9~999.9	-300~1800		
5	T * 2	-199.9~400.0	-300~750		
6	R * 2	0~1700	32~3100	- 0.15% of F.S - 1digit	* 1 0 ~ 400 °C : ± 5 % of F.S ± 1 digit
7	B * 1	0~1800	32~3300		
8	S	0~1700	32~3100		
9	L * 2	-199.9~900.0	-300~1300	± 0.10% of F.S ± 1digit	* 2
10	N	-200~1300	-300~2400	± 0.20% of F.S ± 1digit	
11	U * 2	-199.9~400.0	-300~750	- 0.10% of F.S - 1digit	* 3 0 °C and below : +0.2 % of F.S + 1 digit
12	W	0~2300	32~4200		
13	Platinel II	0~1390	32~2500		
20	JPt100 * 3	-199.9~500.0	-199.9~999.9	- 0.10% of F.S - 1digit	* 3
21	Pt100 * 3	-199.9~640.0	-300~1180		
30	1.000 ~ 5.000 V	1.000 ~ 5.000 V		- 0.10% of F.S - 1digit	-150.0 ~ 150.0 °C : ± 0.2 % of F.S ± 1 digit
32	-10.00 ~ 20.00 mV	-10.00 ~ 20.00 mV			
33	0.0 ~ 100.0 mV	0.0 ~ 100.0 mV			

※ Current input : The current input (4 ~ 20 mA DC) is available with input code 30.

You must use the resistance 250 Ω (0.5 W / 0.1 %) on input terminals.

13 OUTPUT GROUP SETTING

This process controller is divided into 2 types: UNIVERSAL TYPE AND HEATING / COOLING TYPE. Output is selectable from Relay, SSR, and Current (4~20mA DC).

Output type range (output code) is ①~③ for universal type and ④~⑫ for Heating /Cooling type. Sometimes retransmission output and alarm output are not available according to control output (EX. When you choose output code (OT) 2, it is current output of Universal type. In this case, retransmission output and alarm output are available. But, In Heating / Cooling control type with SSR on Heating side and Relay output on Cooling side (output code ⑩), the retransmission output is available but alarm output 3 is not available.

⚠ CAUTION

When setting, "Input type selection number" must be selected in the input type selection mode and also "Output type selection number" must be selected in the output type selection mode before moving to other mode. If not, data of other group will be changed to prior value.

Signal	Name	Description	Condition	Initial value
	Output group	Output type and mode selection	—	—
GoUt	Output signal	Refer to type of control output	Always	(3 / 12)
oUt	Output operation	REV: Reverse DIR: Direct action	Output code 1 ~ 3	REV
oARct	Cycle time	1 ~ 1000 sec	Relay / SSR	30 sec
Ct	Cycle time of cooling output	1 ~ 1000 sec	Output code 4 ~ 12	30 sec
CtC	Hysteresis of univesal type	EUS (0.0 ~ 100.0 %)	ON/OFF Control	EUS (0.5 %)
HYS	Hysterecis of Heating / Cooling type	0.0 ~ 10.0 %	Heating / Cooling	0.5 %
Po	Output volume when input disconnection Output 1(Out1)	Universal : -5.0 ~ 105.0 % Heating / Cooling : 0.0 ~ 105.0 %	Always	0.0 %
Pol	Output volume when input disconnection Output 2(Out2)	0.0 ~ 105.0 %	Heating / Cooling	0.0 %
oL-H	Maximum value	Universal : OL-L + 1Digit~105.0% Heating / Cooling : 0.0 ~ 105.0 %	PID Control	100.0 %
oL-L	Minimum value	Universal : -0.5 % ~ OL-H-1Digit Heating / Cooling : 0.0 ~ 105.0 %	PID Control	0.0 % 100.0%

■ Type of control output (Universal type)

Model	Output code (O T)	OUT1		OUT2
		Relay	SSR / Current	SSR / Current / Retransmission
PX9-0□	0	Relay ON / OFF		Retransmission
PX7-0□	1		SSR	Retransmission
PX3-0□	2		Curren	Retransmission
PX2-0□	3	Relay		Retransmission

■ Type of control output (Heating / Cooling type)

Model	Output code (O T)	Heating (OUT1)		Cooling (OUT2)	
		Relay	SSR / Current	Relay	SSR / Current / Retransmission
PX9-0□ PX7-0□ PX3-0□ PX2-0□	4		SSR		SSR
	5		Current		SSR
	6	Relay	Retransmission		SSR
	7		SSR		Current
	8		Current		Current
	9	Relay	Retransmission		Current
	10		SSR	Relay(AL3)	Retransmission
	11		Current	Relay(AL3)	Retransmission
	12	Relay		Relay(AL3)	Retransmission

14 SET VALUE GROUP SETTING

Set value group is indicated with selecting Local mode or Remote mode in GROUP CONTROL (Not Program mode). "Select number of SV" is after setting 3 type of set value in Local mode, select each set value from external contact input to operate. After selecting number of set value, press  key, you could set set-value of SV1, SV2, and SV3.

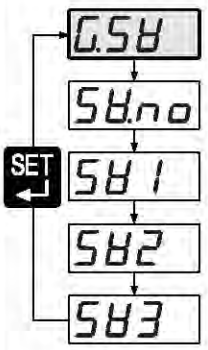
Signal	Name	Description	Condition	Initial value
	Set value group	Set value setting	—	—
	Select number of set value	1 ~ 3	REM / LOCA	1
	Set SV 1	EU(0.0 ~ 100.0 %)	REM / LOCA	EU(0.0 %)
	Set SV 2	EU(0.0 ~ 100.0 %)	REM / LOCA	EU(0.0 %)
	Set SV 3	EU(0.0 ~ 100.0 %)	REM / LOCA	EU(0.0 %)

* EU : Value at an engineering unit in compliance with the range of an instrument.

If Program mode is selected in Group Control, the controller becomes a programmable (ramp/soak) controller with 1 pattern of 10 step. After setting time and set value, this controller controls automatically.

- A pattern is a series of steps. Each step consists of a SV and time setting.

An Increasing or decreasing SV is set for time period, and each time setting is in hours/ minutes or minutes/ seconds.

- After wiring, check and power ON. PV and SV will be indicated.

At this time, press key 3sec. to enter **dl SP** (display) in PV and then press key once more to get Group Control (SV is off).

- At this condition, press key to get control mode(Mod) in PV and select program (PROG) in SV using or .

- Press key once more to set program and then press key 3 times to get group control (G: CTL) in PV (SV is off). And then press key to be indicated program group as below.

Set value

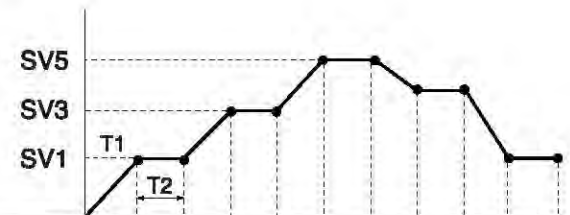

Step NO.	1	2	3	4	5	6	7	8	9	10
Pat-tern	SV SV1	SV2	SV3	SV4	SV5	SV6	SV7	SV8	SV9	SV10
	TIM T1	T2	T3	T4	T5	T6	T7	T8	T9	T10

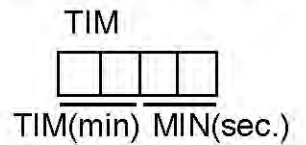

Signal	Name	Description	Condition	Initial value
	Program group	—	—	—
	start / Reset selection	OFF: Reset / ON: Start	PROG	OFF
	Time unit	H.MIN: 99 H 59 min. M.SEC: 99 M 59 sec.	PROG	M.SEC
	Wait Zone	OFF / EUS(1 ~ 10 %)	PROG	OFF
	Wait Time	OFF(0.00) ~ 99.59 (Refer to time unit)	PROG	OFF(0.00)
	Start set value	0.0 ~ 100.0 % of input range	PROG	EU(0.0 %)
	Standard of start	SSV: Start set value / PV1: Process value, PV2: time prior set value	PROG	SSV
	Set SV1	EU(0.0 ~ 100.0 %)	PROG	EU(0.0 %)
	Time setting of fist step	OFF / 0.00 ~ 9959	PROG	OFF
~~~~~				
	Set SV10	0.0 ~ 100.0 %	PROG	EU(0.0 %)
	Time setting of tenth step	OFF / 0.00 ~ 99.59	PROG	OFF
	Condition select after finishing program control	Reset / Repeat / Local / Hold	PROG	RST

## 16 AUTO TUNING

This controller has two types of auto-tuning as STD (Standard type) and LOW(Low PV type). Low PV type is the value 10% lower than the set value. Use this type where overshoot is to be suppressed.

※ Auto-tuning: The Auto-tuning function automatically measures, computes and set the optimum P.I.D and ARW constants. The Auto-tuning function can be activated at any time during the process after power ON; while temperature is rising or when control has stabilized.

Auto tuning is not operated when selecting "OFF" in selection mode of auto tuning start.

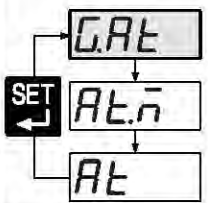
Signal	Name	Description	Condition	Initial value
	Auto tuning group	Indicates Auto tuning	—	—
	Auto tuning type	STD / LOW	ABS	STD
	Auto tuning start	OFF / 1~3 / AUTO	ABS	OFF

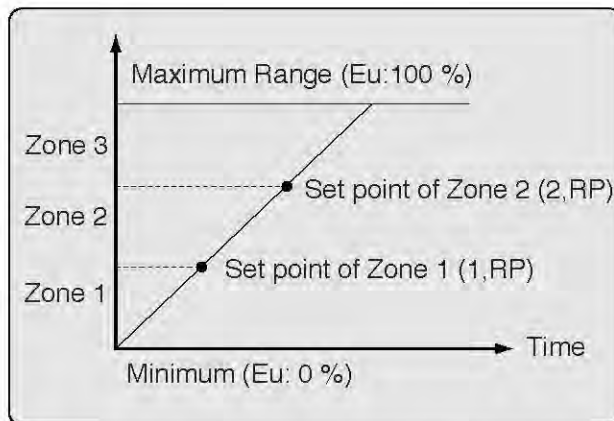

When checking P.I.D. values or setting SV in manual mode, this can be done in P.I.D. Group. Press key to get Anti Reset Wind value by auto or manual and then press once more to be indicated P.I.D mode which is selectable 3 types of P.I.D group (0~3). Example, "0" is no P.I.D mode and after Auto tuning "1" using or and pressing , it is available to change P.I.D value in zone "1" ("2" and "3" are same as "1")

When integral time is 0, manual reset mode is indicated and then you could set reset value to remove off set (range: -5 % ~ 105.0 % of proportional band). You could set 3 zones by selecting zone mode ON.

※ In diagram, "n" is available to set 1 ~ 3 and proportional band of cooling side, integral time of cooling side, hysteresis are indicated in Heating / Cooling type.

Signal	Name	Description	Condition	Initial value
	P.I.D group	Set P.I.D mode	—	—
	Anti Reset Wind-Up	Auto / 50.0 ~ 200.0 %	P.I.D control	Auto
	P.I.D group selection	0 / 1 ~ 3	Always	0
	n. Proportional band(P)	0.1 (H/C TYPE:0.0) ~ 999.9 %	P.I.D group	5.0 %
	n. Integral time (I)	OFF / 1 ~ 600 sec.	Always	240 sec.
	n. Derivative time (D)	OFF / 1 ~ 6000 sec.	Always	60 sec.
	n. Manual reset	-5.0 ~ 105.0 %	Integral time: OFF	50.0%
	n. Proportional band of cooling side (P)	0.0 (ON/OFF control) / 0.1 ~ 999.9	Heating · Cooling type	5.0 %
	n. Integral time of cooling side (I)	OFF / 1 ~ 6000 sec.	Heating · Cooling type	240 sec.
	n. Derivative time of cooling side (D)	OFF / 1 ~ 6000 sec.	Heating · Cooling type	60 sec.
	n. Hysteresis	-100.0 ~ 50.0 %	Heating · Cooling type	3.0 %
	n. Zone point	EU (0) < 1.RP < 2.RP < EU (100.0 %)	ZONE = ON	EU (100.0 %)

# 18 ALARM GROUP SETTING

There are 3 alarm outputs available per controller. In Alarm Group, setting are made for mode, dead band, and value of each alarm. Refer to the next page for the 19 different types of alarm functions.

* : ① In Heating · Cooling type of PX7, * is not indicated when selecting 10,11,12

** : ② In PX7, * * is not indicated because of no third alarm output.

In Heating · Cooling type of PX3, PX2, PX9, * * is not indicated when selecting 10, 11, 12

Signal	Name	Description	Condition	Initial value
	Alarm group	Set alarm mode	—	—
	Type of Alarm 1	OFF / 1 ~ 22 Refer to "Alarm type and code"	Always	1
*	Type of Alarm 2			2
*	Type of Alarm 3			1
	Dead band of Alarm 1	EUS ( 0.0 ~ 100.0 % )	Always	EUS(0.5 %)
*	Dead band of Alarm 2			
*	Dead band of Alarm 3			
	Set value of Alarm 1	PV alarm, Deviation alarm EU ( -100.0 ~ 100.0 % )	Always	EU(100.0 %)
*	Set value of Alarm 2			EU(0.0 %)
*	Set value of Alarm 3			EU(100.0 %)

※ Reference : Display lamp will be OFF when output ON in inverted type.

## ■ Hold function

Without hold function, Low limit alarm will be ON when increasing temperature. (Picture 1)

### ● Hold function : None

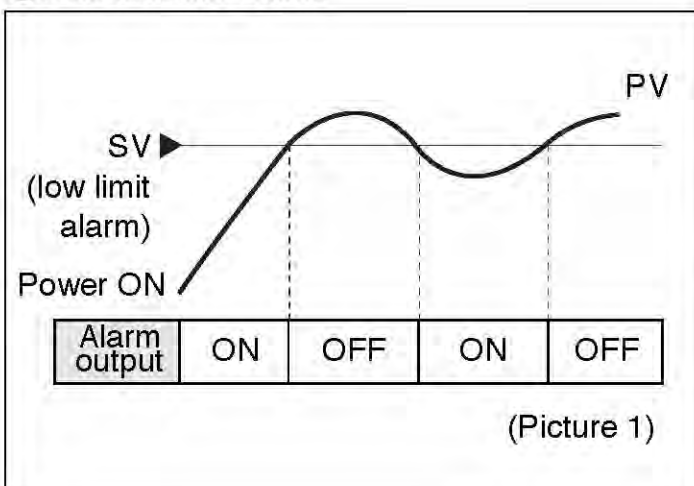



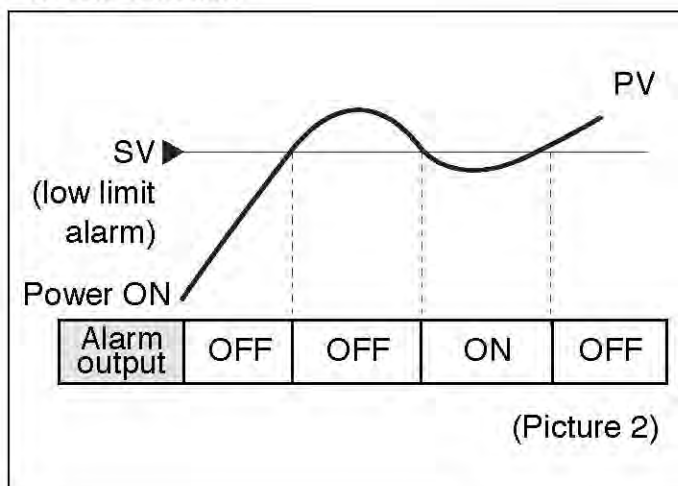







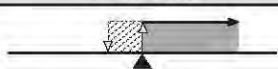
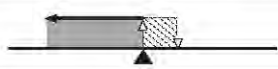



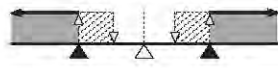

### ● Hold function

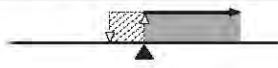
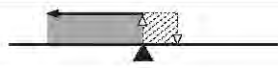

# 19 ALARM TYPE AND CODE

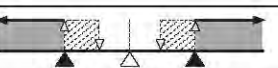
[Notice] Display lamp will be ON when output OFF in inverted type.

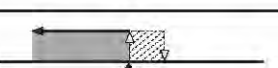
Hysteresis  (△ : Set point , -▲ : Minus Alarm set point , ▲ : Alarm set point )

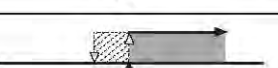
Code NO.	Alarm type	Function
1	High absolute value	
2	Low absolute value	
3	High deviation value	
4	Low deviation value	
5	High deviation value (inverted)	
6	Low deviation value (inverted)	
7	High · Low deviation value	
8	High · Low band	
9	High absolute (inverted)	
10	Low absolute (inverted)	
11	High absolute with hold function	
12	Low absolute with hold function	
13	High deviation with hold function	
14	Low deviation with hold function	
15	High deviation with hold function (inverted)	
16	Low deviation with hold function (inverted)	
17	High · Low deviation with hold function	
18	High · Low band with hold function	
19	High absolute value with hold function (inverted)	
20	Low absolute value with hold function (inverted)	
21	Heater break alarm 1 ( HBA 1 )	
22	Heater break alarm 2 ( HBA 2 )	

## 20 RETRANSMISSION GROUP

※ Reference : Retransmission group will be indicated when selecting retransmission in output group.

If selecting code 4,5,7 or 8 in output group, retransmission will not be indicated.

Signal	Name	Description	Condition	Initial value
	Retransmission group	Set retransmission mode	※Reference	—
	Retransmission type or Power for sensor	PV / SV / Output volume (MV) Power for sensor (SPS)	Optional	PV
	Hight limit of retransmission	Thermocouple / R.T.D : FR -H ~ FR- L	PV / SV	
	Low limit of retransmission	DC voltage : SL -H ~ SL-L but, RET. H > RET.L		

## 21 COMMUNICATION

PX series are equipped with 4 wire /2 wire half-duplex the RS485 / RS422 communication interfaces.

Using the interfaces, communications are available with maximum 31 devices.

Signal	Name	Description	Condition	Initial value
	Communication group	Set communication mode	—	—
	RS485/RS422 Protocol	PC.LINK(Set value:0) / PC.LINK SUM (Set value:1)	Optional	0
	Communication rate (B.P.S)	600(SV:0) / 1200(SV:1) / 2400(SV:2) 4800(SV:3) / 9600(SV:4)		4
	Parity check	NONE(SV:0) / EVEN(SV:1) / ODD(SV:2)		1
	Stop bit	1 bit (SV:1) / 2 bit (SV:2)		1
	Data length	7 bit (SV:7) / 8 bit (SV:8) (Except PC LINK :8)		8
	Address	1 ~ 99 , maximum 31 devices		1
	Response time	0 ~ 10. response time = (handling time + response time) X 10 ms		0

## 22

# HEATER BREAK ALARM GROUP

Heater break alarm group consist of output dead band and current detection display mode and detects 2 spots (to be ordered seperately: current transformer model CTL-6-S. measurement range : 1 ~ 50 A).

Signal	Name	Description	Condition	Initial value
	Heater break alarm group	Set HBA mode	—	—
	Current setting mode of HBA 1	OFF / 1 ~ 50 A	Optional	OFF
	Current setting mode of HBA 2	OFF / 1 ~ 50 A		OFF
	Hysteresis setting mode HBA 1	EUS (0.0 ~ 100.0 %)		EUS (0.5 %)
	Hysteresis setting mode HBA 2	EUS (0.0 ~ 100.0 %)		EUS (0.5 %)
	Current measurement value of HBA 1	Only display (0 ~ 50 A)		
	Current measurement value of HBA 2	Only display (0 ~ 50 A)		

* : It is not indicated in PX7. (There is no HBA function in PX2, PX3)

## 23

# REMOTE INPUT GROUP

If selecting REMOTE in Control group, set value will be set by remote set.

In remote condition, SV is changeable by front keys, but the controller is controlled by external set value. Do not change set value by remote in auto tuning.

Signal	Name	Description	Condition	Initial value
	Remote group	Set remote mode	—	—
	High limit voltage of remote input	1,000 ~ 5,000 V but, R. INH > R. INL	Optional	5,000
	Low limit voltage of remote input			1,000
	High limit on scale	Thermocouple : FR-H ~ FR-L DC voltage : SL-H ~ SL-L Decimal point is set by DP-P.		* 1
	Low limit on scale			* 2
	PV Filter	OFF / 1 ~ 120		OFF
	PV Bias	EUS (-100.0 ~ 100.0 %)		EUS (0.0 %)

* 1 : Thermocouple, R.T.D input ( FR-H ), DC voltage ( SL-H )

* 2 : Thermocouple, R.T.D input ( FR-L ), DC voltage ( SL-L )

* EUS : Range at an engineering unit in compliance with the span of an instrument.

MEMO

HALYOUNG

MEMO

HALYOUNG

# **HAN YOUNG**

#1381-3, Juan-dong, Nam-gu, Incheon, Korea  
TEL:(82-32) 876-4697 FAX:(82-32) 876-4696  
<http://www.hynux.com> E-mail: [sdt@hyelec.co.kr](mailto:sdt@hyelec.co.kr)